

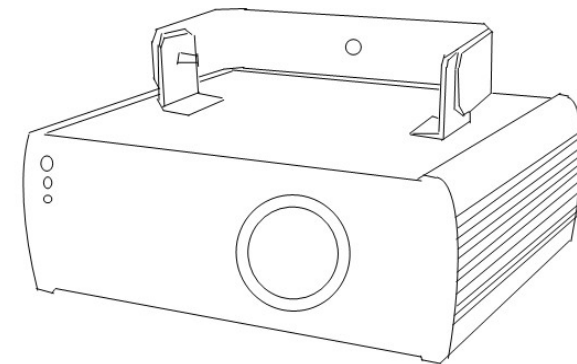

RGB LASER SHOW SYSTEM



User's Manual



Read this manual before using. Do not attempt to open the housing or repair this device by yourself without contact us!

This chart lists the DMX dipswitch setting for DMX address 1 through 511. Follow the instructions below to configure fixture dipswitches with you desired DMX address.

DMX Address Quick Reference Chart

DipSwitch Position

DMX : DIPSWITCH SET		#9	0	0	0	0	0	0	0	0	1	1	1	1	1	1	1	1		
0=OFF		#8	0	0	0	0	1	1	1	1	0	0	0	0	1	1	1	1		
1=ON		#7	0	0	1	1	0	0	1	1	0	0	1	1	0	0	1	1		
X=OFF or ON		#6	0	1	0	1	0	1	0	1	0	1	0	1	0	1	0	1		
#1	#2	#3	#4	#5																
0	0	0	0	0		32	64	96	128	160	192	224	256	288	320	352	384	416	448	480
1	0	0	0	0	1	33	65	97	129	161	193	225	257	289	321	353	385	417	449	481
0	1	0	0	0	2	34	66	98	130	162	194	226	258	290	322	354	386	418	450	482
1	1	0	0	0	3	35	67	99	131	163	195	227	259	291	323	355	387	419	451	483
0	0	1	0	0	4	36	68	100	132	164	196	228	260	292	324	356	388	420	452	484
1	0	1	0	0	5	37	69	101	133	165	197	229	261	293	325	357	389	421	453	485
0	1	1	0	0	6	38	70	102	134	166	198	230	262	294	326	358	390	422	454	486
1	1	1	0	0	7	39	71	103	135	167	199	231	263	295	327	359	391	423	455	487
0	0	0	1	0	8	40	72	104	136	168	200	232	264	296	328	360	392	424	456	488
1	0	0	1	0	9	41	73	105	137	169	201	233	265	297	329	361	393	425	457	489
0	1	0	1	0	10	42	74	106	138	170	202	234	266	298	330	362	394	426	458	490
1	1	0	1	0	11	43	75	107	139	171	203	235	267	299	331	363	395	427	459	491
0	0	1	1	0	12	44	76	108	140	172	204	236	268	300	332	364	396	428	460	492
1	0	1	1	0	13	45	77	109	141	173	205	237	269	301	333	365	397	429	461	493
0	1	1	1	0	14	46	78	110	142	174	206	238	270	302	334	366	398	430	462	494
1	1	1	1	0	15	47	79	111	143	175	207	239	271	303	335	367	399	431	463	495
0	0	0	0	1	16	48	80	112	144	176	208	240	272	304	336	368	400	432	464	496
1	0	0	0	1	17	49	81	113	145	177	209	241	273	305	337	369	401	433	465	497
0	1	0	0	1	18	50	82	114	146	178	210	242	274	306	338	370	402	434	466	498
1	1	0	0	1	19	51	83	115	147	179	211	243	275	307	339	371	403	435	467	499
0	0	1	0	1	20	52	84	116	148	180	212	244	276	308	340	372	404	436	468	500
1	0	1	0	1	21	53	85	117	149	181	213	245	277	309	341	373	405	437	469	501
0	1	1	0	1	22	54	86	118	150	182	214	246	278	310	342	374	406	438	470	502
1	1	1	0	1	23	55	87	119	151	183	215	247	279	311	343	375	407	439	471	503
0	0	0	1	1	24	56	88	120	152	184	216	248	280	312	344	376	408	440	472	504
1	0	0	1	1	25	57	89	121	153	185	217	249	281	313	345	377	409	441	473	505
0	1	0	1	1	26	58	90	122	154	186	218	250	282	314	346	378	410	442	474	506
1	1	0	1	1	27	59	91	123	155	187	219	251	283	315	347	379	411	443	475	507
0	0	1	1	1	28	60	92	124	156	188	220	252	284	316	348	380	412	444	476	508
1	0	1	1	1	29	61	93	125	157	189	221	253	285	317	349	381	413	445	477	509
0	1	1	1	1	30	62	94	126	158	190	222	254	286	318	350	382	414	446	478	510
1	1	1	1	1	31	63	95	127	159	191	223	255	287	319	351	383	415	447	479	511

DipSwitch Position

DMX Address



Unpacking:













Thank you for purchasing this product. Please read user guide for safety and before using the product. Keep this manual for future reference. This product can create perfect laser programs and effects since it has passed a series of strictly tests before delivery. Please check the attachments listed on the page after opening the carton. Immediately upon receiving a fixture, carefully unpack the box. Check the box contents to ensure that all parts are present and that they are in good condition. If any part appears damaged from shipping, or if the box shows signs of mishandling, notify the shipper immediately. In addition, retain the box and all the packing material for inspection. In any event, save the carton and all packing material because, in case that you have to return the fixture to the factory, you will have to do so in its original box, with its original packing.

- 1. Laser Light: 1PCS
- 2. Power Cable: 1PCS
- 3. User Guide: 1PCS

Safety Notice:

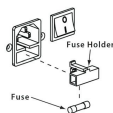
Please read the following notes carefully because they include important safety information about the installation, usage and maintenance of this product. It is important to read all these notes before starting to work with this product.

<p>Lasers can be hazardous and have unique safety considerations. Permanent eye injury and blindness is possible if lasers are used incorrectly. Pay close attention to each safety REMARK and WARNING statement in the user manual. Read all instructions careful</p>	
	<p>There are no user serviceable parts inside the light. Any reference to servicing this unit you may find from now on in this User Manual will only apply to properly C we certified technicians. Do not open the housing or attempt any repairs unless you are o</p>
	<p>Please refer to all applicable local codes and regulations for proper installation of the light.</p>
	<p>Keep this manual for future consultation. If you sell the light to another user, make sure that they also receive this manual.</p>

	Avoid direct eye exposure to the light source while the fixture is on. Always disconnect the light from its power source before servicing. Always connect the light to a grounded circuit to avoid the risk of electrocution.		
	This product is for indoor use only! Use only in dry locations. Keep this device away from rain and moisture, excessive heat, humidity and dust. Do not allow contact with water or any other fluids, or metallic objects.		
	Make sure there are no flammable materials close to the fixture(s) while operating.		Please prevent this light away from electrical shock
	When hanging this fixture, always secure it to a fastening device using a safety cable (not provided).		
Power 110V 240V Ground	Always make sure that you are connecting the light to the proper voltage, as per the specifications in this manual or on the product's sticker. Never connect the light to a dimmer pack. Make sure that the power cable is not cracked, crimped or damaged. Ne		
	The maximum ambient temperature (Ta) is 104 F (40 C). Do not operate the fixture at a higher temperature. In case of a serious operating problem, stop using this product immediately!		
	Use cleaning tissue to remove the dust absorbed on the external lenses periodically to optimize light output.		
	Do not remove or break the warranty label, otherwise it void the warranty.		
	Always replace with the exact same type fuse, replacement with anything other than the specified fuse can cause fire or electric shock and damage your unit, and will void your manufactures warranty.		
	There are no serviceable parts in the light. Please have all servicing and adjustments made by a qualified service engineer.		
	Don't throw this product away just as general trash, please dispose of this product following the abandon electronic product regulation in your country.		To protect the environment, recycle packing material wherever possible.

Troubleshooting

- If the power supply indicator doesn't light up and the laser doesn't work, please check the power supply, the input voltage and the fuse.
- In Stand-Alone operation, if the power supply indicator is light up and sound active indicator isn't light up, but the laser is shut off doesn't work.
 - Because sound is too small make for laser shut off in sound active, please increase the music volume or increase audio sensitivity with sensitivity knob, please check as below.
 - Please check if unit has been set up in slave mode, then set up in master mode.
- In Master-Slave operation, slave unit don't function, please check as below.
 - Make sure to there's only one master in the chain, and the others are set in slave mode.
 - Make sure to control the unit without DMX console controlling.
 - Make sure to take a good quality power cable and connection.
- In DMX mode operation, the laser is OFF and the DMX signal indicator is unlighted, please check as below.
 - Make sure to set up the DMX mode.
 - Make sure to have a good connection.
- In DMX operation, the unit can't be controlled by the DMX console, but the DMX signal indicator is flashing, please make sure the DMX console and unit have the same channel.
- If the unit is fail, please turn off the unit, then turn on again after 5 minutes.

Warranty Warnings:

- Damages caused by the disregard of this user manual are not subject to Warranty. The dealer will not accept liability for any
- Please consider that unauthorized modifications on the device are forbidden due to safety reasons. Please note that damages caused by manual modifications on the device or unauthorized operation by unqualified persons are not subject to warranty.
- If this device will be operated in any way different to the one described in this manual, it may suffer damages and the guarantee becomes void. Furthermore, any other operation may lead to dangers like short-circuit, burns electric shock, etc.

After trying the above solution you still have a problem, please contact your dealer or our company for service.

ch8 value	Color	ch8 value	Color	ch8 value	Color	ch8 value	Color
6~7	yellow/Y	70~71	PCR	134~135	WPYB	198~199	WPCYR
8~9	blue/B	72~73	PCG	136~137	PCYB	200~201	WPCYG
10~11	red/B	74~75	PYB	138~139	PCYR	202~203	PCYBR
12~13	green	76~77	CYB	140~141	PCYG	204~205	PCYBG
14~15	wP	77~79	CYR	142~143	PCBR	206~207	PCBRG
16~17	wC	80~81	CYG	144~145	PCBG	208~209	CYBRG
18~19	wY	82~83	CBR	146~147	CYBR	210~211	CYBRW
20~21	PC	84~85	CBW	148~149	CYBG	212~213	CYBGW
22~23	PY	86~87	YBR	150~151	CYRG	214~215	YBRGW
24~25	PB	88~89	YBG	152~153	CYRW	216~217	YBRGP
26~27	CY	90~91	YBW	154~155	CYRB	218~219	YBRWP
28~29	CB	92~93	YCW	156~157	YBRG	220~221	BRGWP
30~31	CR	94~95	YPR	158~159	YBRW	222~223	BRGWC
32~33	YB	96~97	BRG	160~161	YBRP	224~225	BRWPC
34~35	YR	98~99	BRP	162~163	YBWC	226~227	RGWPC
36~37	YG	100~101	BRW	164~165	YBPC	228~229	RGWPY
38~39	BR	102~103	BGP	166~167	BRGW	230~231	RGWCY
40~41	BG	104~105	BGW	168~169	BRGP	232~233	GWPCB
42~43	BW	106~107	RGC	170~171	BRGC	234~235	GWPYB
44~45	RG	108~109	RGP	172~173	BRWP	236~237	GPCYR
46~47	RP	110~111	RGW	174~175	BRWC	238~239	WPCYBR
48~49	RW	112~114	RWC	176~177	RGWP	240~241	PCYBRG
50~51	GC	114~115	RWY	178~179	RGWC	242~243	CYBRGW
52~53	GP	116~117	GWC	180~181	RGWY	244~245	YBRGWP
54~55	GW	118~119	GWY	182~183	RGPC	246~247	BRGWPC
56~57	WPC	120~121	GPY	184~185	RGPY	248~249	RGWPCY
58~59	WPY	122~123	GBC	186~187	GWPY	250~251	GWPCYB
60~61	WPB	124~125	GRY	188~189	GWPB	252~253	WPCYBRG
62~63	WPR	126~127	WPCY	190~191	GWPR	254~255	moving WPCYBRG

1. There are 52 static patterns, the sizes of the patterns that DMX value is 170 previous are adjustable, the following irregular patterns are non-adjustable. There are 52 dynamic patterns, whose sizes are non-adjustable.
2. Only circle pattern has color segment function, it needs to operate with both CH8 and CH9.

Laser Safty Warnings

Potential laser injury hazard exists with this product! Read these Instructions carefully, which include important information about installation, safe use and service!

Caution

- * Avoid direct eye contact with laser light. Never intentionally expose your eyes or others to direct laser radiation.
- *This laser product can potentially cause instant eye injury or blindness if laser light directly strikes the eyes.
- *It is illegal and dangerous to shine this laser into audience areas, where the audience or other personnel could get direct laser beams or bright reflections into their eyes.
- *It is a US Federal offense to shine any laser at aircraft.

NON-INTERLOCKED HOUSING WARNING

- *This unit contains high power laser devices internally. Do not open the laser housing, due to potential exposure to unsafe levels of laser radiation. The laser power levels accessible if the unit is opened can cause instant blindness, skin burns and fires.

Installation

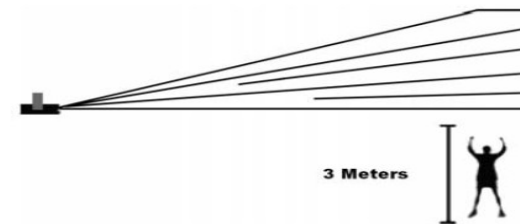

AVOID EYE DIRECT CONTACT!

- *Laser effects projected 3 meters (9.8 ft) above the audience are eye safe. A survey should be taken to assess the likelihood of any reflective surfaces (such as high windows, chrome bars etc) bouncing stray beams back down into the audience.
- *Using a fastening clamps on the light and tight to the ceiling in a strong hook..
- *Make sure its correct power output and plug the power cable to the wall socket.
- * Power must be in earth! Power on the light.
- * Do not shoot the beams to the audience!
- *Do not look direct into the laser aperture once the laser light is ON. Please pay attention to the Laser Danger Warning Label!

Technical Specification

- Voltage: bi-voltage 110V -220V-250V AC, 50HZ-60HZ/ Fuse: 2A/250V
- Rated Power: 30W
- Laser:

Color	Wavelength	Power output
Red	650nm	200mW
Green	532nm	50mW
Blue	470nm	150mW
Mixed white: 400mW		
- Laser class: **Class IIIB**
- Working Modes: DMX, Sound Active, AUTO, Master-Slave
- DMX Control Channel: 7 channels
- Graphics & Effects: more than 100 patterns, over 300 effects
- Interface: 3 pins XLR jack for DMX or Maser-Slave linking
- inner box: 310*245*170(0.013m³), carton: 515*330*382(0.065m³), 4pcs/carton
- N.W.: 1.8kg, G.W: 2.4Kg

Features

- Seven-color laser light
Includes seven-color effects as red, green, blue, yellow, cyan, purple, and white. It can combine to create rich and dynamic patterns at the same time, more than 100 laser patterns, over 1000 laser effects.
- Various working modes
Includes four working modes as DMX, Sound Active, AUTO and Master-Slave Control mode, different working modes has different program for different applications.
- DMX control
The unit has 9 channels to control in DMX mode. The unit has BLACK OUT function. The unit will shut OFF if no DMX512 signal.
- Master-Slave function
The system allow link many units (as slave unit) together to doing synchro job without console in sound active or AUTO mode.
- LED indicating and shut-off function
In sound active mode, the unit's panel has LED indicating for sound active. The unit will shut off after 8 seconds when the music stops.
- DPSS Laser
Use Diode-Pumped Solid State green, red blue lasers, stable output and long working life.

CH2 Parameter Chart For Patterns Selection

DMX value	Static patterns	Dynamic patterns	DMX value	Static patterns	Dynamic patterns
0~4	one circle	circle to big	130~134	triangle 2	two hori dot line mov
5~9	empty circle	empty circle to big	135~139	dot triangle 2	vertical line move
10~14	dot circle	dot circle to big	140~144	chiasma line	vert-dot line move
15~19	scan circle	scan circle to big	145~149	chia-dot line	two vertical line mov
20~24	two circle	circle roll	150~154	square	two vert-dot line mov
25~29	three circle	empty circle roll	155~159	dot square	square extend
30~34	four circle	dot circle roll	160~164	rectangle	dot square extend
35~39	two emp-circle	circle turn	165~169	dot rectangle	pentagon extend
40~44	two dot circle	dot circle to add	170~174	many hori-line	square turn
45~49	hor-extend line	circle jump	175~179	many vert-line	pentagon turn
50~54	hori-shrink line	scan circle extend	180~184	tetragon 1	line scan
55~59	hori-flex line	circle flash	185~189	tetragon 2	dot line scan
60~64	horizontal line	empty circle roll	190~194	pentagon 1	wave turn
65~69	hori-dot line	two circle turn	195~199	pentagon 2	dot wave turn
70~74	vertical line	four circle turn	200~204	pentagon 3	wave flowing
75~79	hori-dot line	diagonal jump	205~209	wave line 1	dot wave flowing
80~84	45° diagonal	sector to big	210~214	wave line 2	sine wave
85~89	dot diagonal	dot sector to big	215~219	wave line 3	dot sine wave
90~94	two hori-line	diagonal move	220~224	wave dot line	tetragon turn
95~99	two hori-dot line	dot diagonal move	225~229	spirality line	pentagon star 1 turn
100~104	two vert-line	long sector round	230~234	welcome	pentagon star 2 turn
105~109	two vert-dot line	short sector round	235~239	horizontal dot	square dot jump
110~114	V line	three line round	240~244	vertical dot	bird fly
115~119	V dot line	hori line move	245~249	many dot 1	many dot jump 1
120~124	triangle 1	hori dot line move	250~254	square dot	V pattern move
125~129	dot triangle 1	two hori line move	255	many dot 2	many dot jump 2

CH8 Parameter Chart For Color Selection

ch8 value	Color	ch8 value	Color	ch8 value	Color	ch8 value	Color
0~1	white/W	64~65	WPG	128~129	WPCB	192~193	GWCY
2~3	purple/P	66~67	PCY	130~131	WPCR	194~195	GWCB
4~5	cyan/C	68~69	PCB	132~133	WPCG	196~197	WPCYB

DMX address calculation

For DMX mode, DMX address from #1 to #9 dipswitches must be set, the address is set from 1 to 511. Each dipswitch represents a binary value.

Dipswitch	Value	Dipswitch	Value
#1	1	#6	32
#2	2	#7	64
#3	4	#8	128
#4	8	#9	256
#5	16	#10	DMX, Set to "0"

One unit has 5 channels, so each unit must be assigns 5 channels at least. We may assign 8 channels for one unit, then DMX address = $8 * N + 1$, $N=0, 1, 2, 3 \dots$ Example, One loop address=1, two loop address=9, three loop address=17, four loop address=25

Loop	Address	Binary	Dipswitches
1	1	10000000	#1
2	9	10010000	#1+#4
3	17	100010000	#1+#5
4	25	100110000	#1+#4+#5

The dipswitches setting for DMX address see the " DMX Address Quick Reference Chart ".

DMX Control

The system only accepts the DMX512 signal of international standard to control the system.

DMX Control Parameter Chart

Channel	Function	Value	Description
CH1	Mode	0~49	Close, laser OFF
		50~99	Static patterns of DMX mode
		100~149	Dynamic patterns of DMX mode
		150~199	Sound active mode
		200~255	Auto mode
CH2	Pattern selection	0~255	52 static/dynamic patterns
CH3	Position-X	0~255	Adjust position-X
CH4	Position-Y	0~255	Adjust position-Y
CH5	Scanning speed	0~255	0 is speedy, 255 is slow
CH6	Dynamic patterns play speed	0~255	0 is speedy, 255 is slow, has ten grade speed
CH7	Static pattern size	0~255	0 is small, 255 is big
CH8	Color Selection	0~255	RGBYCPW, 7 colors combined
CH9	Color Segment	0~255	Divide into 1 to 51 segment

Front/Rear Panel

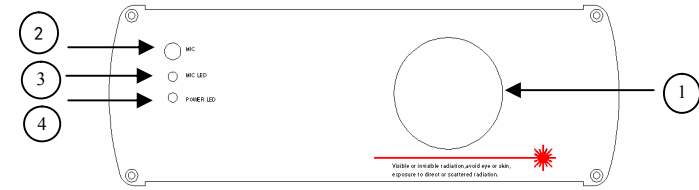

Front Panel Figure

1. Laser Aperture
2. Sound Active Microphone
3. Sound Active Indicator:Blue
4. Power Indicator:Red

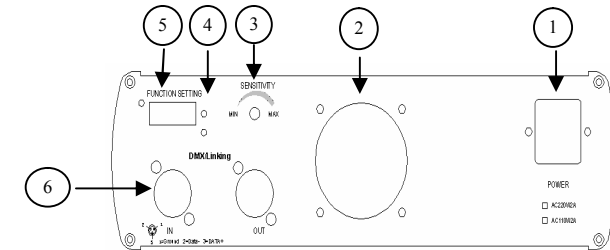

Rear Panel Figure

1. Power Jack
2. Cooling Fan
3. Audio Sensitivity Knob
4. DMX Signal Indicator: Green
5. Dipswitches: Function Setting
6. DMX or Linking Jack

Function & Setting

Sound Active

The change of the laser pattern is controlled by sound, that is, the rhythm of the sound control the effect of the changing laser pattern. Turning the sensitivity knob in the clockwise direction to increase the fixture's sensitivity to sound, the knob in the counter clockwise direction to decrease. The laser diode will automatically turn off after 8 seconds when the music stops.

AUTO

Auto cycles the built-in programs without being controlled externally. It has no laser OFF.

The mode allows a single unit to react to the beat of the music in the master mode.

1. Install the units in a suitable position (laying or appending).

2. Set dipswitch to select Sound Active or AUTO mode.
 3. Turn on the unit power, the unit begins reset, then the unit begins working.
 4. The unit will react to the low frequencies of music via the internal microphone.
- Adjust the audio sensitivity knob on the back of the unit to make the unit more or less sensitive in sound active. The panel has LED indicating for sound active.

Master-Slave Operation

This mode will allow you to link up to 32 units together without controller.

1. Install the units in a suitable position (laying or appending).
2. Choose a unit to function as Master mode, set dipswitch to select Sound Active or AUTO mode. The others must be set to Slave mode, set dipswitch to select Slave mode.
3. Use standard XLR microphone cable chain your units together via the XLR connector on the rear of the units. For longer cable runs we suggest a terminator at the last fixture. Cabling must have a male XLR connector on one end and a female XLR connector on the other end.

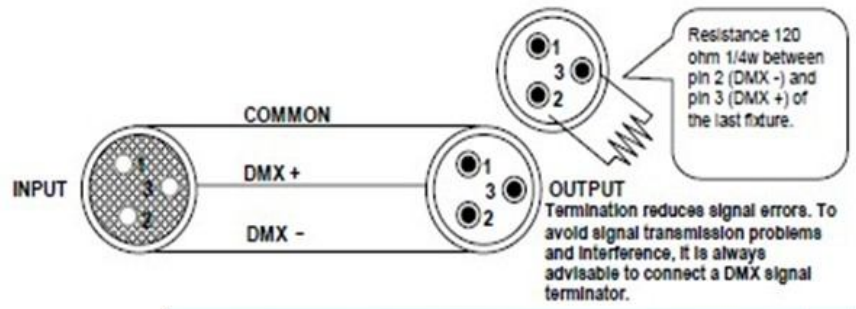

Caution: Do not allow contact between the common and the fixture's chassis ground. Grounding the common can cause a ground loop, and your fixture may perform erratically. Test cables with an ohm meter to verify correct polarity and to make sure the pins are not grounded or shorted to the shield or each other.

4. Turn on the all units' power, the units begins reset, then the unit begins working.

The slave units will react the same as the master unit.

5. The units will react to the low frequencies of music via the internal microphone. Adjust the audio sensitivity knob on the back of the master unit to make the unit more or less sensitive in sound active. The panel has LED indicating for sound active.

Universal DMX Operation (DMX mode)

This mode allows you to use universal DMX-512 console to operate.

1. Install the units in a suitable position (laying or appending).

2. Use standard XLR microphone cable chain your units together via the XLR connector on the rear of the units. For longer cable runs we suggest a terminator at the last fixture.
3. Assign a DMX address to each the unit using dipswitches, see the "DMX Address Quick Reference Char".

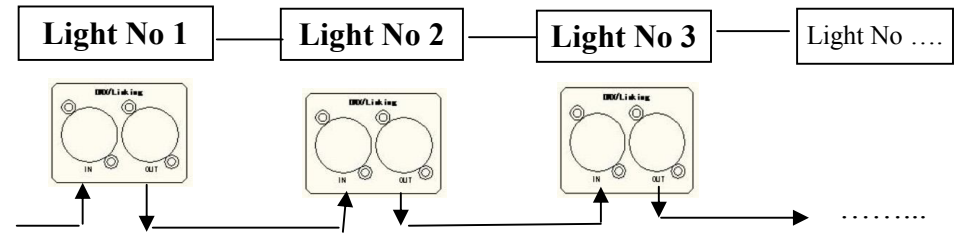

DMX Signal

- 1: MASTER: SOUND/AUTO/DMX 2: SLAVE 2: SLAVE

4. Turn on the all units' power, the units begins reset, then the unit begins working.
5. Use DMX console to control your units.

Notes:

1. DMX console can not be used in Master-Slave operation (Sound Active or AUTO mode).
2. There should be only one master unit in Master-Slave operation.

DMX Control

The system only accepts the DMX512 signal of international standard to control the system mode, the laser beam ON /OFF, running direction, running speed and twinkle speed etc.

Function setting

Uses dipswitches to assign a unit's function: DMX/slave, or sound active, or AUTO mode.

For the unit is DMX mode, set the DMX address using dipswitch. Each dipswitch represents a binary value. See the "Function chart".

DIPSWITCH CHART										FUNCTION
#1	#2	#3	#4	#5	#6	#7	#8	#9	#10	
X	X	X	X	X	X	X	X	0	1	SOUND ACTIVE
X	X	X	X	X	X	X	X	1	1	AUTO MODE
SET DMX ADDRESS FOR DMX MODE									0	DMX / SLAVE

Built-In Program Function Chart